

2002

On incidence coloring for some cubic graphs

Wai Chee Shiu
Hong Kong Baptist University, wcshiu@hkbu.edu.hk

Peter Che Bor Lam
Hong Kong Baptist University, cblam@hkbu.edu.hk

Dong-Ling Chen
Shandong University of Science and Technology

Follow this and additional works at: https://repository.hkbu.edu.hk/math_ja



Part of the [Mathematics Commons](#)

This document is the authors' final version of the published article.

Link to published article: [https://dx.doi.org/10.1016/S0012-365X\(01\)00457-5](https://dx.doi.org/10.1016/S0012-365X(01)00457-5)

APA Citation

Shiu, W., Lam, P., & Chen, D. (2002). On incidence coloring for some cubic graphs. *Discrete Mathematics*, 252 (1-3), 259-266. [https://doi.org/10.1016/S0012-365X\(01\)00457-5](https://doi.org/10.1016/S0012-365X(01)00457-5)

This Journal Article is brought to you for free and open access by the Department of Mathematics at HKBU Institutional Repository. It has been accepted for inclusion in Department of Mathematics Journal Articles by an authorized administrator of HKBU Institutional Repository. For more information, please contact repository@hkbu.edu.hk.

On Incidence Coloring for Some Cubic Graphs*

W.C. Shiu[†], Peter C.B. Lam[†], and Dong-Ling Chen[‡]

Abstract

In 1993, Brualdi and Massey conjectured that every graph can be incidence colored with $\Delta + 2$ colors, where Δ is the maximum degree of a graph. Although this conjecture was solved in the negative by an example in [1], it might hold for some special classes of graphs. In this paper, we consider graphs with maximum degree $\Delta = 3$ and show that the conjecture holds for cubic Hamiltonian graphs and some other cubic graphs.

Key words and phrases : Cubic graph, incidence coloring, restrained decomposition

2000 MSC : 05C15, 05C45

1. Introduction

Unless stated otherwise, all graphs in this paper are finite, undirected and simple. Let G be a graph and let $V(G)$, $E(G)$ and $\Delta(G)$ (or simply V , E and Δ) be vertex-set, edge-set and maximum degree of G respectively. The set of all neighbors of a vertex u is denoted by $N_G(u)$ or simply by $N(u)$. Therefore $d(u)$, the degree of vertex u , is $|N(u)|$. Let

$$I(G) = \{(v, e) \in V(G) \times E(G) \mid v \text{ is incident with } e\}$$

be the set of *incidences* of G . We say that two incidences (v, e) and (w, f) are *adjacent* if one of the following holds:

- (1) $v = w$;
- (2) $e = f$;
- (3) the edge vw equals to e or f .

We may consider G as a digraph by splitting each edge uv into two opposite arcs (u, v) and (v, u) . Let $e = uv$. We identify (u, e) with the arc (u, v) . So $I(G)$ may be identified with the set of all arcs $A(G)$. Two distinct arcs (incidences) (u, v) and (x, y) are adjacent if one of the following holds:

*Partially supported by RGC, Hong Kong; FRG, Hong Kong Baptist University.

[†]Department of Mathematics, Hong Kong Baptist University.

[‡]Department of Applied Mathematics and Software Engineering, Shandong University of Science and Technology Tai'an 271019, People's Republic of China.

- (1') $u = x$;
- (2') $u = y$ and $v = x$;
- (3') $v = x$.

An *incidence coloring* σ of G is a mapping from $I(G)$ to a *color-set* C such that adjacent incidences of G are assigned distinct colors.

If $\sigma : I(G) \rightarrow C$ is an incidence coloring of G and $k = |C|$, then we say that G is *k-incidence colorable* and σ is called a *k-incidence coloring*. The minimum cardinality of C for which there exists an incidence coloring $\sigma : I(G) \rightarrow C$ is called the *incidence chromatic number* of G , and is denoted by $\chi_i(G)$.

This concept was first developed by Brualdi and Massey [3] in 1993. They posed the Incidence Coloring Conjecture (*ICC*), which states that for every graph G , $\chi_i(G) \leq \Delta + 2$. In 1997, Guiduli [5] showed that incidence coloring is a special case of directed star arboricity, introduced by Algor and Alon [1]. They pointed out that the *ICC* was solved in the negative following an example in [1]. He considered the Paley graph of order p with $p \equiv 1 \pmod{4}$. Following the analysis in [1], he showed that $\chi_i(G) \geq \Delta + \Omega(\log \Delta)$, where $\Omega = \frac{1}{8} - o(1)$. Making use of a tight upper bound for directed star arboricity, he obtained the upper bound $\chi_i(G) \leq \Delta + O(\log \Delta)$.

Brualdi and Massey determined the incidence coloring number of trees, complete graphs and complete bipartite graphs [3]; D.L.Chen *et al.* determined the incidence coloring number of paths, cycles, fan, wheels, adding-edge wheels and complete 3-partite graphs [4]. In this paper, we shall consider the incidence chromatic numbers for some cubic graphs. First we state the following lemma.

Lemma 1.1: *Let G_1, G_2, \dots, G_n be disjoint graphs. If $G = G_1 \cup G_2 \cup \dots \cup G_n$, then*

$$\chi_i(G) = \max\{\chi_i(G_j) \mid j = 1, 2, \dots, n\}.$$

Because of Lemma 1.1, we assume that all graphs under consideration are connected and simple. The following theorem can be found in [4].

Theorem 1.2: *For any graph G with $\Delta(G) \leq 2$, $\chi_i(G) \leq \Delta(G) + 2$.*

In this paper, we prove *ICC* holds for some cubic graphs G . If $uv \in E(G)$, then $\sigma(uv)$ is written as $(\sigma(u, v), \sigma(v, u))$. Therefore $\sigma(vu) = (\beta, \alpha)$ if $\sigma(uv) = (\alpha, \beta)$.

2. Cubic Graphs

In this section, we shall consider some special cubic graphs whose incidence chromatic number

is less than or equal to 5. We shall first give two examples.

Example 2.1: Consider the graph $G = C_3 \times P_2$ below. Suppose $\chi_i(G) \leq 4$. Let σ be the optimal coloring. Without loss of generality, we may assume $\sigma(a, b) = 1$, $\sigma(b, c) = 3$ and $\sigma(c, a) = 2$. Then $\sigma(c, b) = 1$ or 4. If $\sigma(c, b) = 4$, then $\sigma(b, a) = 2$. We cannot color the arc (b, y) . Thus $\sigma(c, b) = 1$. Then $\sigma(by) = (4, 1)$, $\sigma(ax) = (4, 2)$ and $\sigma(cz) = (4, 3)$ (see Figure 3). We cannot color the edge xy . Therefore, $\chi_i(G) = 5$. ▀

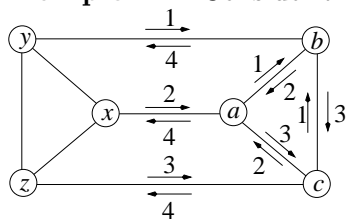

Figure 3

Using a similar argument of Example 2.1, we obtain the following corollary.

Corollary 2.1: Suppose G is graph. If G contains a triangle adjacent with two 4-cycles, then $\chi_i(G) \geq 5$.

Example 2.2: Figure 4 shows that there exists a 2-edge-connected cubic graph with a 4-incidence coloring. It is clear that there is no 3-incidence coloring for it.

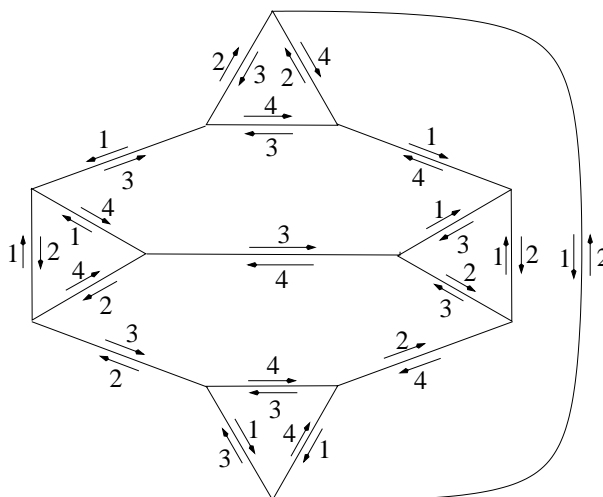

Figure 4

Form now on, let G be a cubic Hamiltonian graph of order p and $C_p = x_1x_2 \cdots x_px_1$ be a Hamilton cycle of G . Let $F = E(G) \setminus E(C_p)$. Then F is a 1-factor (perfect matching) of G . If $x_ix_j \in F$, then x_i is called the *matched vertex* (under F) of x_j and vice versa. If $p = 2n$, then x_{i+n} is called the *antipodal vertex* of x_i and vice versa for $1 \leq i \leq n$. It is easy to show the following lemma.

Lemma 2.3: *Let G be a cubic Hamiltonian graph with a Hamilton cycle C and a perfect matching F . Then either G contains two adjacent vertices whose matched vertices are not adjacent or each vertex is matched with its antipodal vertex.*

Theorem 2.4: *Let G be a cubic Hamiltonian graph, then $\chi_i(G) \leq 5$.*

Proof: Suppose the order of G is p . Let $C_p = x_1x_2 \cdots x_px_1$ be a Hamilton cycle of G . Let x_s and x_r be the matched vertices of x_1 and x_p respectively. By Lemma 2.3, we may assume that either x_s and x_r are not adjacent or the matched vertex of each vertex is its antipodal vertex.

For convenience, we take $x_{p+1} = x_1$ and $x_0 = x_p$. Moreover from now on we choose that the residue class of modulo 3 is $\{1, 2, 3\}$ and write $a \equiv k$ to instead of $a \equiv k \pmod{3}$. Now we shall give a 5-incidence coloring σ for G .

We color the cycle C_p by defining σ as

$$\sigma(x_ix_{i+1}) \equiv (2i - 1, 2i) \text{ for } 1 \leq i \leq p - 1; \quad \sigma(x_px_1) = \begin{cases} (4, 5) & \text{if } p \not\equiv 3, \\ (2, 3) & \text{if } p \equiv 3. \end{cases}$$

Now, we are going to color the 1-factor F . First, we color the chords x_1x_s and x_px_r , and some relevant chords.

Case 1: Suppose $p \equiv 3$. Then let $\sigma(x_px_r) = (4, 5)$ and $\sigma(x_1x_s) = (5, 4)$.

Case 2: Suppose $p = 2n \equiv 1$. Then we consider two cases separately:

Subcase 2.1: Suppose x_s and x_r are not adjacent.

In the following, we use x_h, x_i, x_j and x_k to denote the matched vertices of $x_{r-1}, x_{r+1}, x_{s+1}$ and x_{s-1} respectively.

If $r \equiv 3$ then replace the color 1 of the arc (x_r, x_{r-1}) by 4, i.e., redefine $\sigma(x_r, x_{r-1}) = 4$. Let $\sigma(x_{r-1}x_h) = (5, 4)$.

If $r \equiv 1$ then replace the color 1 of the arc (x_r, x_{r+1}) by 4. Let $\sigma(x_{r+1}x_i) = (5, 4)$.

If $s \equiv 1$ then replace the color 3 of the arc (x_s, x_{s-1}) by 5. Let $\sigma(x_{s-1}x_k) = (4, 5)$.

If $s \equiv 2$ then replace the color 3 of the arc (x_s, x_{s+1}) by 5. Let $\sigma(x_{s+1}x_j) = (4, 5)$.

After that, let $\sigma(x_px_r) = (1, 5)$ and $\sigma(x_1x_s) = (3, 4)$.

Subcase 2.2: Each vertex is matched with its antipodal vertex.

In this case $s = n + 1, r = n$ and $n \equiv 2$. Let $\sigma(x_1x_{n+1}) = (3, 4), \sigma(x_nx_{2n}) = (5, 1)$.

Case 3: Suppose $p = 2n \equiv 2$. The coloring is similar to Case 2. We put the details in the Appendix. Also, there are some figures in Appendix to illustrate the coloring on some cases of p, s, r .

The remaining uncolored chords are colored by (4, 5) or (5, 4) arbitrarily. ■

Lemma 2.5 (Petersen, 1891) [6]: *Suppose G is a 2-edge-connected cubic graph, then $E(G)$ can be decomposed into a union of edge-disjoint of cycles and a 1-factor of G .*

A proof of this Lemma can be found in H.P.Yap [7, p.27], or in Behzad, Chartrand and Lesniak-Foster [2, p.165].

Corollary 2.6: *Suppose G is a 2-edge-connected cubic graph. If G can be decomposed into a union of edge-disjoint of cycles C^1, C^2, \dots, C^m and a 1-factor F such that all orders of the cycles are multiples of 3, then $\chi_i(G) \leq 5$.*

Proof: By the proof of Theorem 2.4, we can color all the cycles by colors 1, 2 and 3. Edges in F are colored by (4, 5) or (5, 4). ■

Finally, we conjecture that the *ICC* conjecture holds for cubic graphs.

Appendix:

Proof of Case 3 of Theorem 2.4: Suppose $p = 2n \equiv 2$. Then we consider two cases separately:

Subcase 2.1: Suppose x_s and x_r are not adjacent.

If $r \equiv 1$ then redefine $\sigma(x_r, x_{r-1}) = 4$.

If $r \equiv 2$ then redefine $\sigma(x_r, x_{r+1}) = 4$.

If $s \equiv 1$ then redefine $\sigma(x_s, x_{s-1}) = 5$.

If $s \equiv 2$ then redefine $\sigma(x_s, x_{s+1}) = 5$.

If $s = r - 2 \equiv 2$, then $\sigma(x_{s+1}, x_j) = \sigma(x_{r-1}, x_j) = 3$. If there is an arc incident with x_j and is colored by 3, then change the color to 4 or 5 (at least one color is available). And then let $\sigma(x_j, x_{s+1}) = 5$ or 4 according to the previous choice.

If $r = s - 2 \equiv 2$, then $\sigma(x_{r+1}, x_i) = \sigma(x_{s-1}, x_i) = 3$. The rest procedure is similar to the case when $s = r - 2 \equiv 2$.

Otherwise let

$$\begin{aligned} \sigma(x_{r-1}x_h) &= (5, 4) \text{ if } r \equiv 1; & \sigma(x_{r+1}x_i) &= (5, 4) \text{ if } r \equiv 2; \\ \sigma(x_{s+1}x_j) &= (4, 5) \text{ if } s \equiv 2; & \sigma(x_{s-1}x_k) &= (4, 5) \text{ if } s \equiv 1. \end{aligned}$$

After that let $\sigma(x_p x_r) = (3, 5)$ and $\sigma(x_1 x_s) = (3, 4)$.

Subcase 2.2: Each vertex is matched with its antipodal vertex.

In this case, $n \equiv 1$. First we redefine $\sigma(x_{n+1}, x_{n+2}) = 5$ and $\sigma(x_n, x_{n-1}) = 4$. And then let $\sigma(x_2 x_{n+2}) = (5, 4)$ and $\sigma(x_{n-1} x_{2n-1}) = (4, 5)$. After that let $\sigma(x_p x_r) = (3, 5)$ and $\sigma(x_1 x_s) = (3, 4)$. █

Some figures:

Figures for $p \equiv 1$:

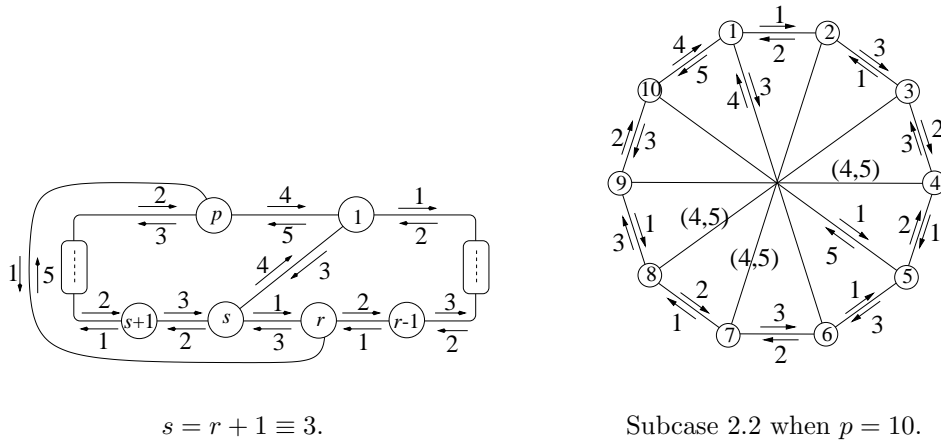
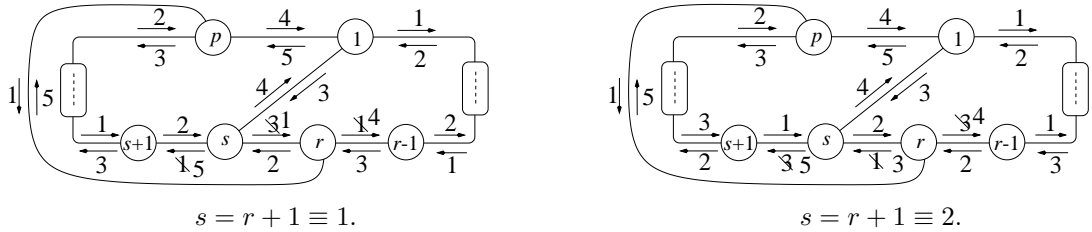
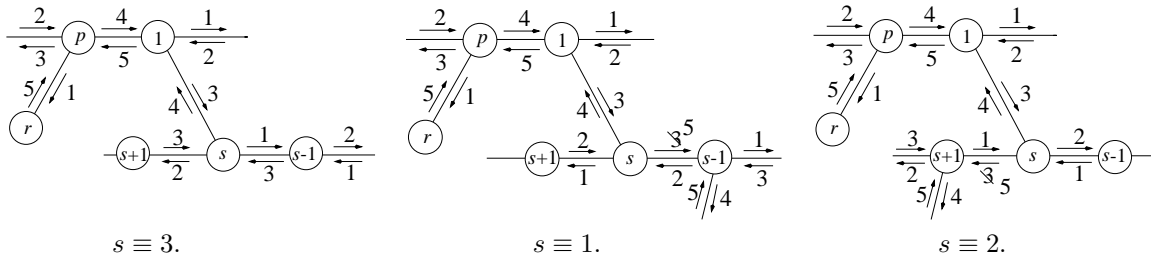
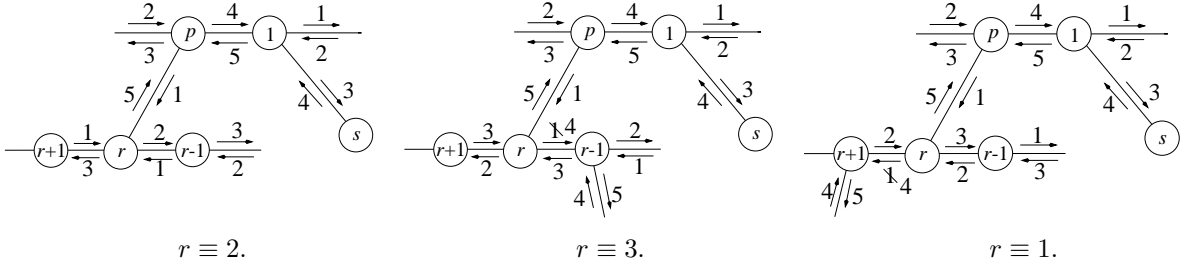

Figures for $p \equiv 2$:

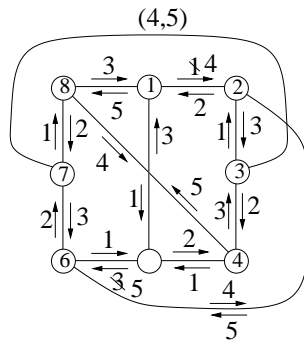
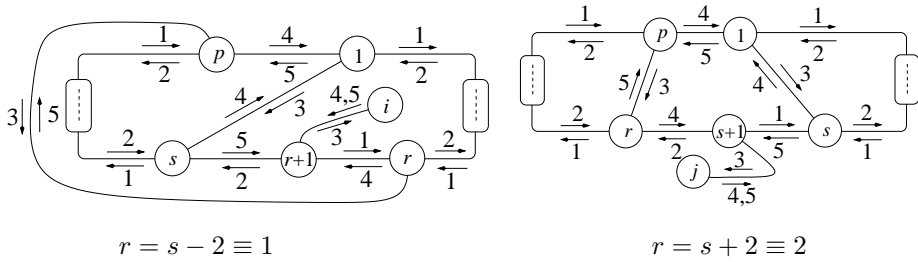
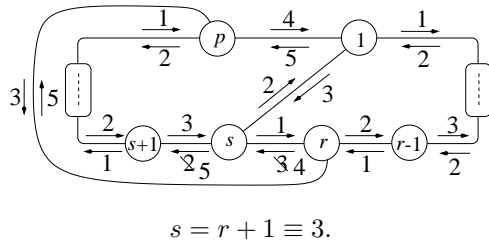
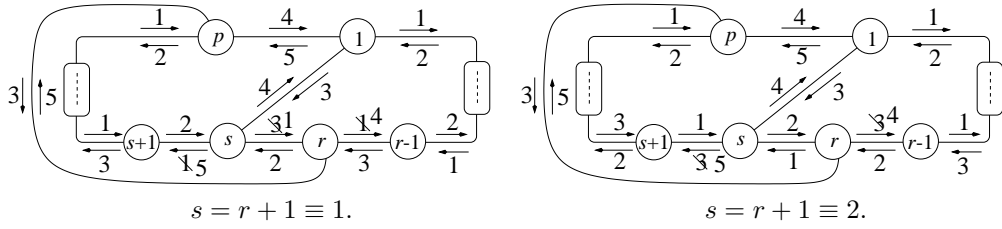
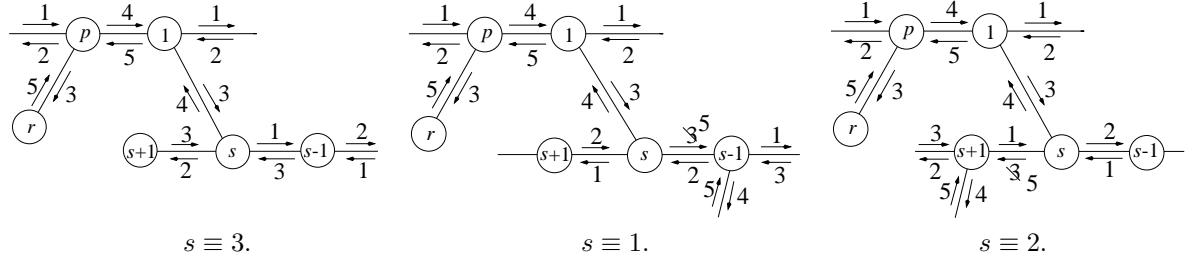
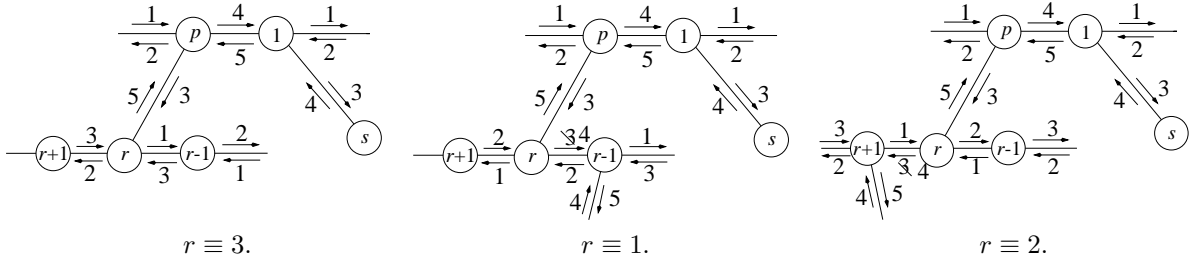

Subcase 3.2 when $p = 8$.

References

- [1] I. Algor and N. Alon, The Star Arboricity of Graphs, *Discrete Math.*, **75** (1989), 11-22.
- [2] M. Behzad, G. Chartrand and L. Lesniak-Foster, *Graphs and Digraphs*, Wadsworth International, 1979.
- [3] R.A.Brualdi and J.Q. Massey, Incidence and Strong Edge Colorings of Graphs, *Discrete Math.*, **122** (1993), 51-58.
- [4] D-L.Chen, X-K.Liu and S-D.Wang, The Incidence Chromatic Number and the Incidence Coloring Conjecture of Graphs, *Math. in Economics*, **15(3)** (1998), 47-51, in P.R.China.
- [5] B. Guiduli, On incidence coloring and star arboricity of graphs, *Discrete Math.*, **163** (1997), 275-278.
- [6] J. Petersen, Die Theorie der regularen Graphen, *Acta Math.*, **15** (1891), 193-220.
- [7] H.P.Yap, *Total Colorings of Graphs*, Lecture Notes in Mathematics 1623, Springer, 1996.